



股票简称：科林电气  
股票代码：603050

KE-6710-V5 7kW

( 32A)

V1.0





V1.0	2023-06-26	





1

2 7KW

2.1

2.2

2.3

2.4

2.5

3

3.1

3.2 " "

4

5

6

7



1

2

3

4

1

7kW



## 2.2

GB/T 20234.1

1

GB/T 20234.2

2

## 2.3

1.0

## 2.4

220V± 15%

50± 1Hz

220V± 15%

50± 1Hz

32A

-25 +60

-25 +60

5% 95%

IP55

3.5kg

190\*300\*100( \* \* ) mm

## 2.5

:

:





1

3s

3

2

3.1

IC

IC

A.

B.

3.2

"

"

"

"

"

"

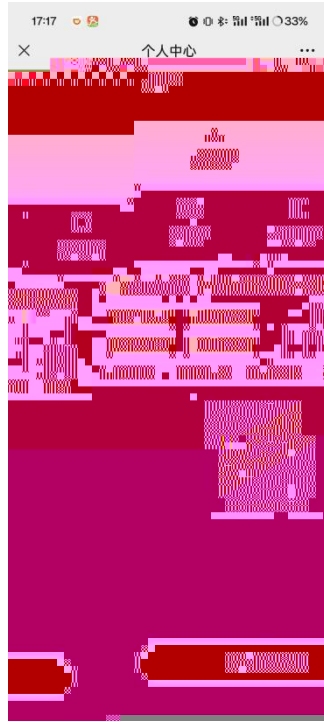
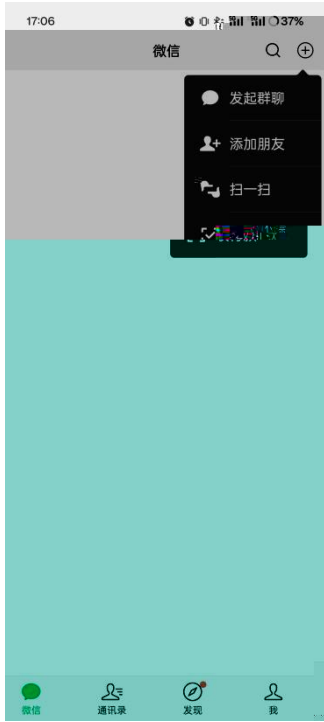

“

”

”

”

B

“ 2 ”

”

”

”



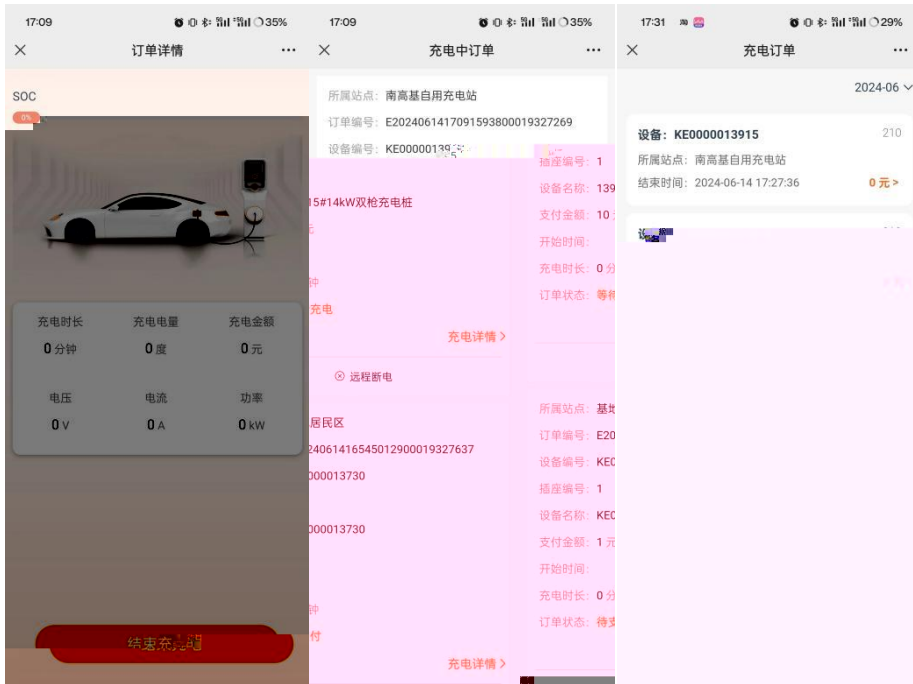

“ ”



“ ”

4

1

7kW 220V

2

( )

(RV5. 5- 4L)

8-10mm

( )

,



单位: mm

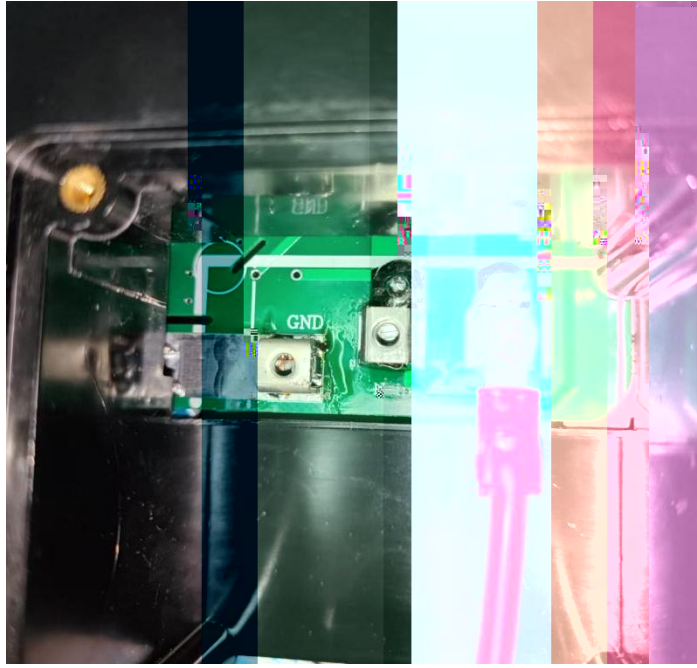

3

1

2

1

1

2

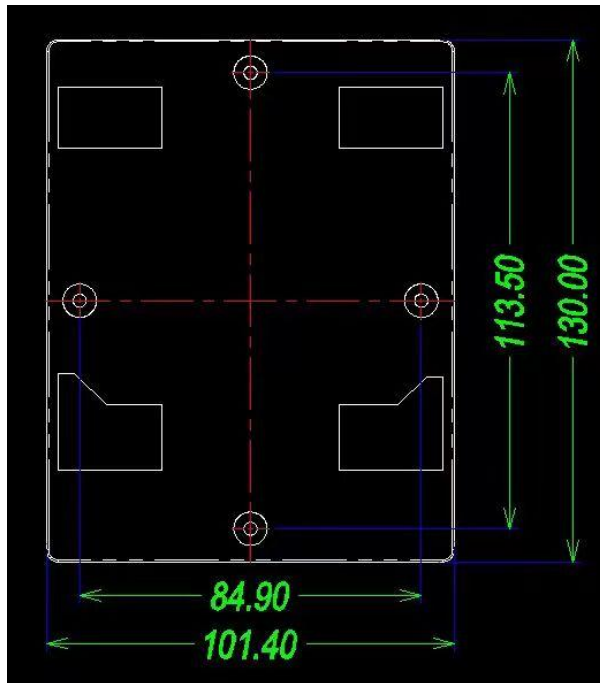

2

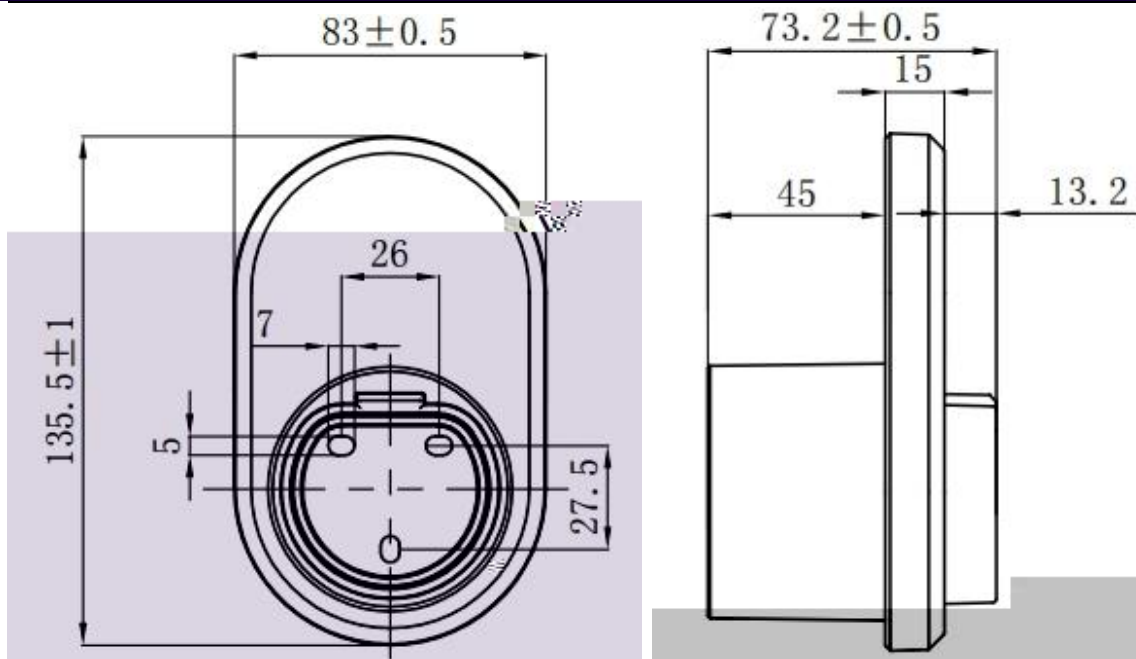

450\*200\*450

\* \*

M10\*80

75\*35mm

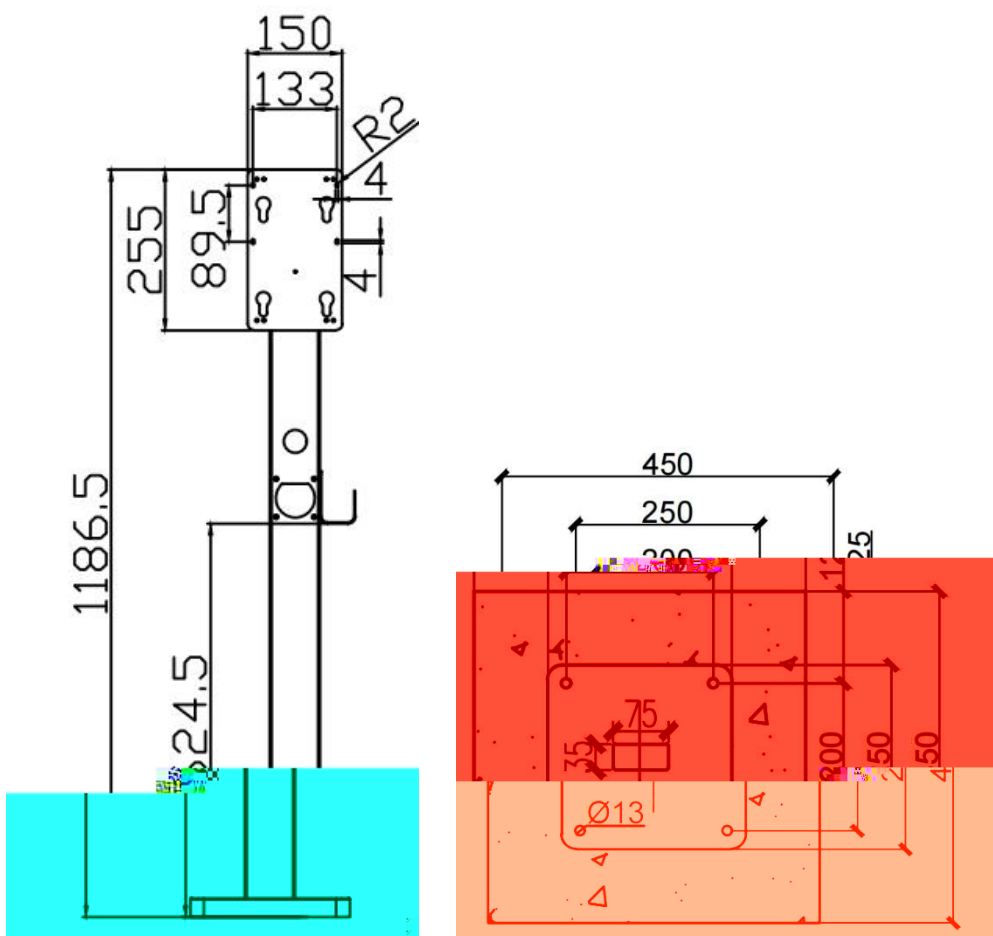

4

3



5

6



# 7

## 7.1

---

---

---

---

## 7.2

## 7.3



1

/

2

(

3

4

1)

2)

3)

8)

9)

10)

5

,

(

)

6

,

7

,

050222

0311-85231078

400-0311-128

0311-69099681